

nasher

MANUAL DE MONTAGEM CÓDIGO 301709 ARMÁRIO AÉREO CANTO DIR/ESQ 2PT NESHER RAINHA 92 X 52CM 100% MDF

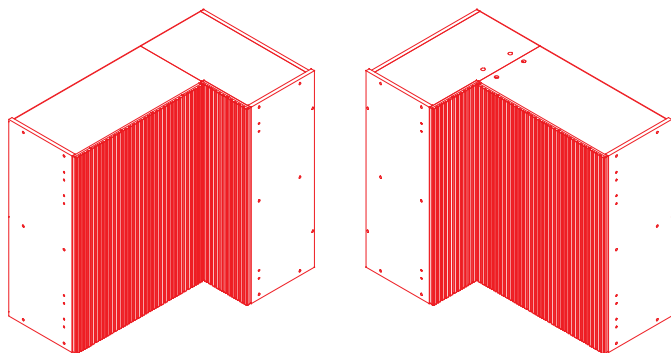

A marca da gestão florestal responsável
FSC® C168299



ESTE PRODUTO PERMITE MONTAGEM PARA AMBOS OS LADOS.

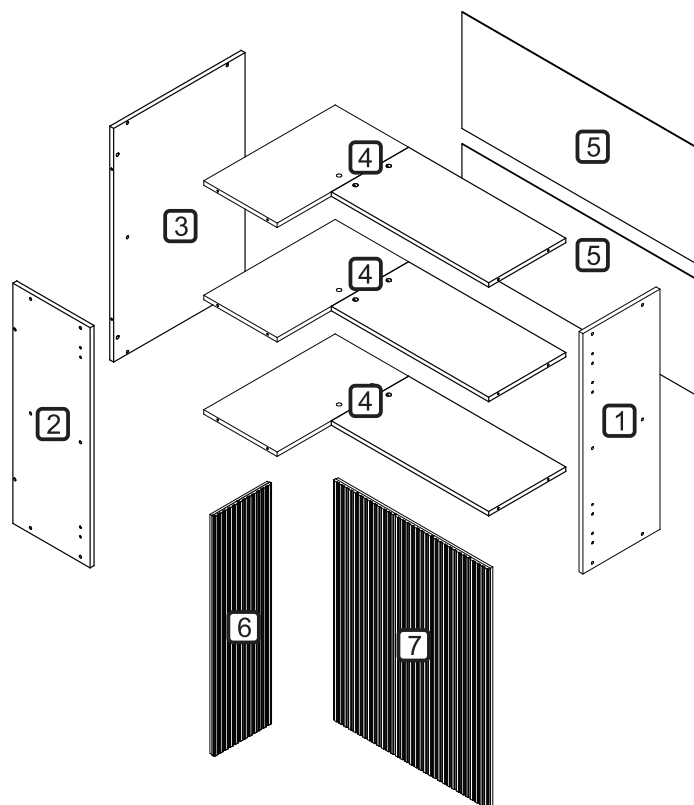

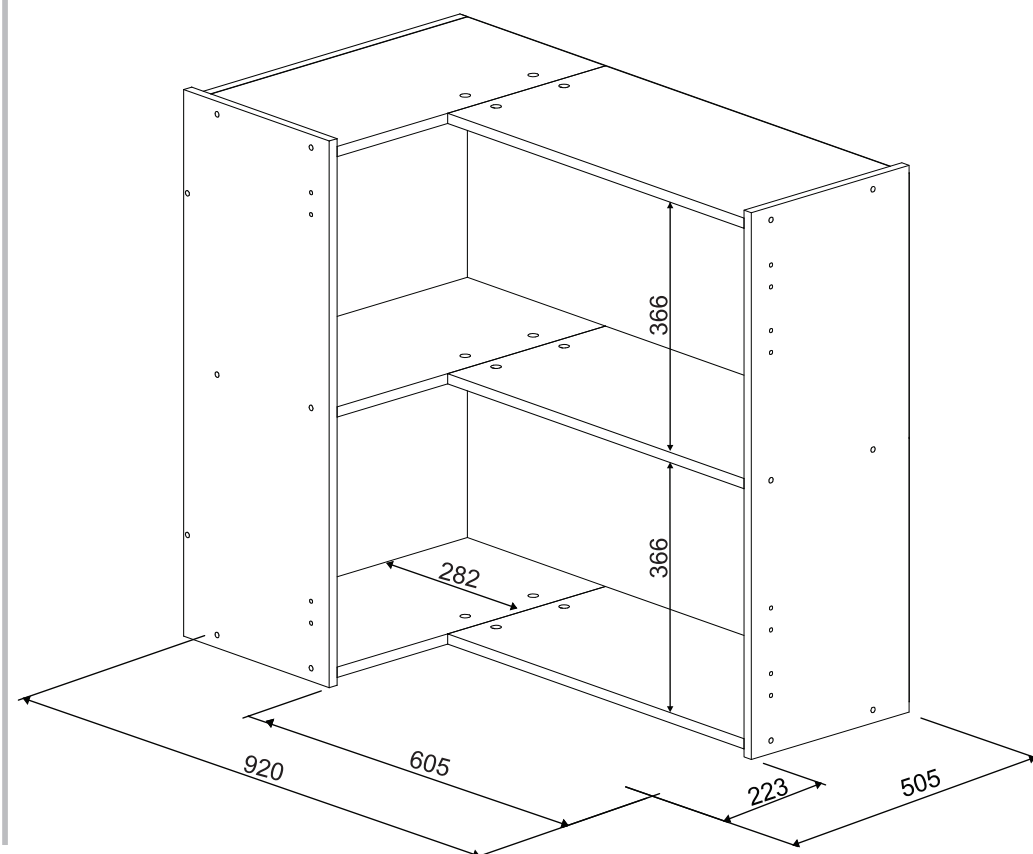
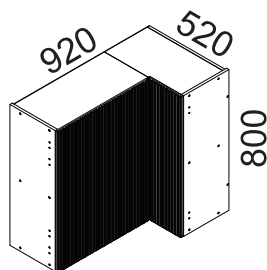

DIMENSÕES DOS ESPAÇOS INTERNOS (MEDIDAS EM MILÍMETRO)

DIMENSÕES MÁXIMAS DO PRODUTO MONTADO

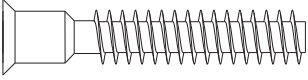
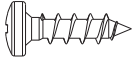
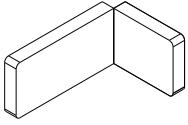
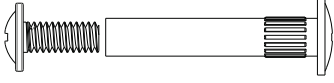
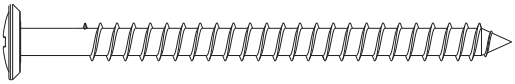
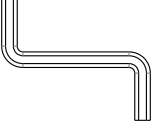
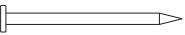
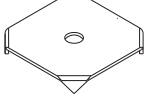
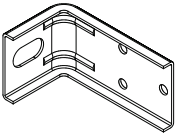
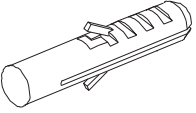
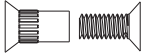

CÓDIGO	DESCRIÇÃO	QTDE	COMP.	LARG.	ESP.
1	LATERAL P/ PORTA	1	800	297	15
2	LATERAL P/ FECHAMENTO	1	800	297	15
3	FECHAMENTO	1	778	505	15
4	PRATELEIRA MONTADA	3	887	505	15
5	FUNDO TRASEIRO	2	914	386	2.5
6	PORTA MENOR MONTADA	1	798	222	18
7	PORTA MONTADA	1	798	597	18

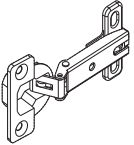
CÓDIGO/DESCRIÇÃO	QUANTIDADE	CÓDIGO/DESCRIÇÃO	QUANTIDADE
A  PARAFUSO 7x40mm CABEÇA CHATA	20	B  PARAFUSO 4x14mm CABEÇA PANELA	24
C  CAPA PLÁSTICA PARA CANTONEIRA	4	D  PARAFUSO UNIAO DE MÓDULOS 28MM	4
E  PARAFUSO 5x65mm CABEÇA FLANGEADA	4	F  CHAVE ZETA	1
G  PREGO 10x10 COM CABEÇA	43	H  FIXADOR FUNDO TRASEIRO METÁLICO	9
I  CANTONEIRA METÁLICA PARA FIXAÇÃO NA PAREDE	4	J  BUCHA DE PAREDE DE 8mm	4
K  PARAFUSO UNIÃO DE MÓDULOS 17MM	13	L  TAPA FURO ADESIVO 12mm	14
M  DOBRADIÇA SLOW MOTION C/ CALÇO RÉTA CANECO 35mm	6		